

# MACH3 Ethernet Breakout Board

## MKX-ET Specification

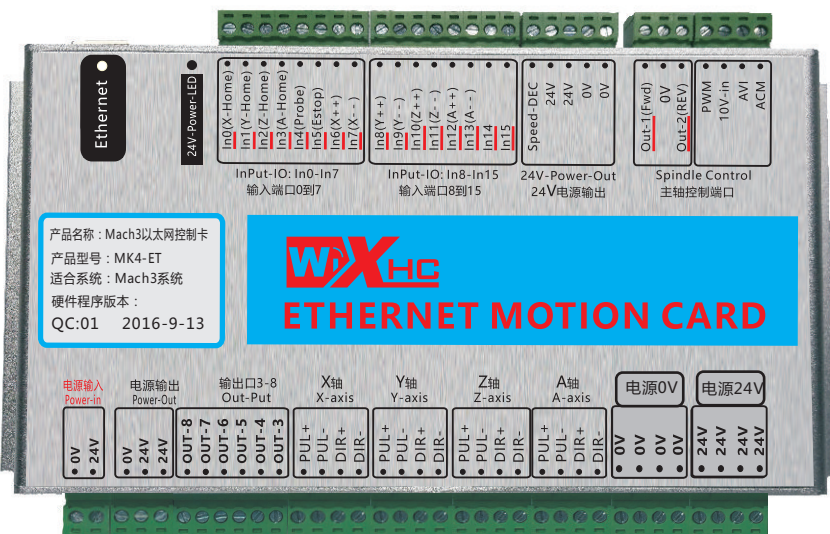

Product Size: 184x127x30mm

MK3-ET: 3 Axis Ethernet breakout board

MK4-ET: 4 Axis Ethernet breakout board

MK6-ET: 6 Axis Ethernet breakout board



### Features:

- ★ Fully supporting all Mach3 versions,support Windows PC,
- ★ Only support Ethernet interface,Need to set IP address  
(Please read the last page for reference)
- ★ Support save data when power off
- ★ Support spindle speed feedback
- ★ Support 10 meters Ethernet interface cable
- ★ Supports Up 6-axis
- ★ Maximum step-pulse frequency is 2000KHz  
16 general-purpose input,8 output
- ★ Velocity feedback function, Spindle speed display in real time
- ★ all IO-port isolation, interference, stable performance
- ★ Support servo motor and step motor

## Simple connection description

### Application Connection Diagram

#### Ethernet Motion Control Card Application

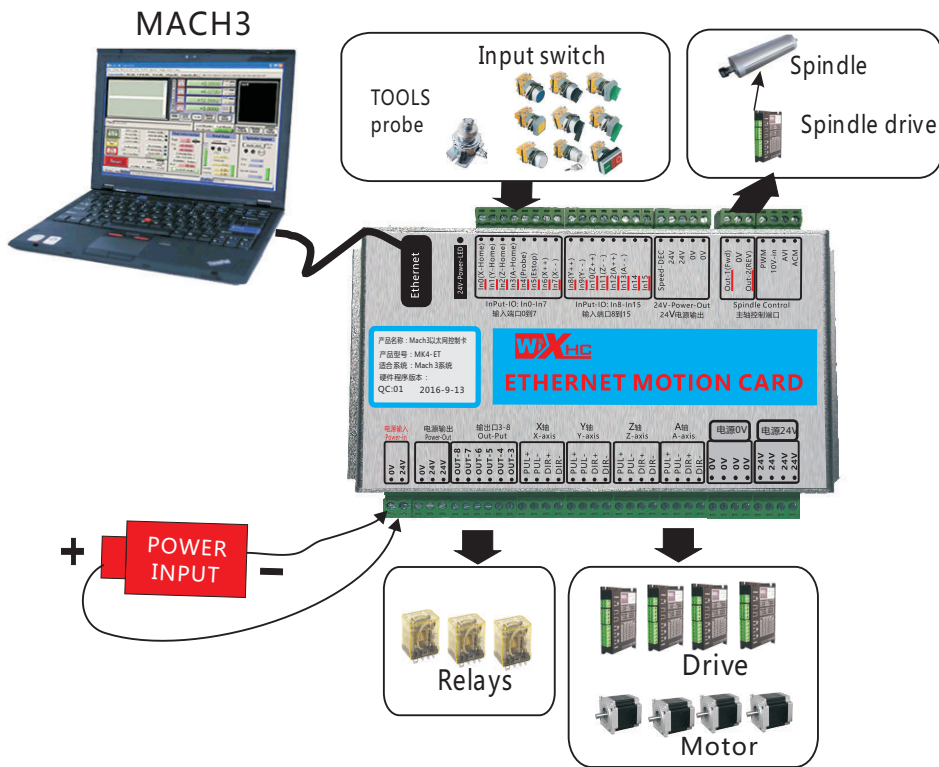

Support: 3-axis or 4-axis, or 6-axis

Mk3-ET: 3-axis; Mk4-ET: 4-axis; Mk6-ET: 6-axis

## Signal Description

Light: Work fine  
 Slow flash: Connect successfully  
 Off: The USB connection is not normal

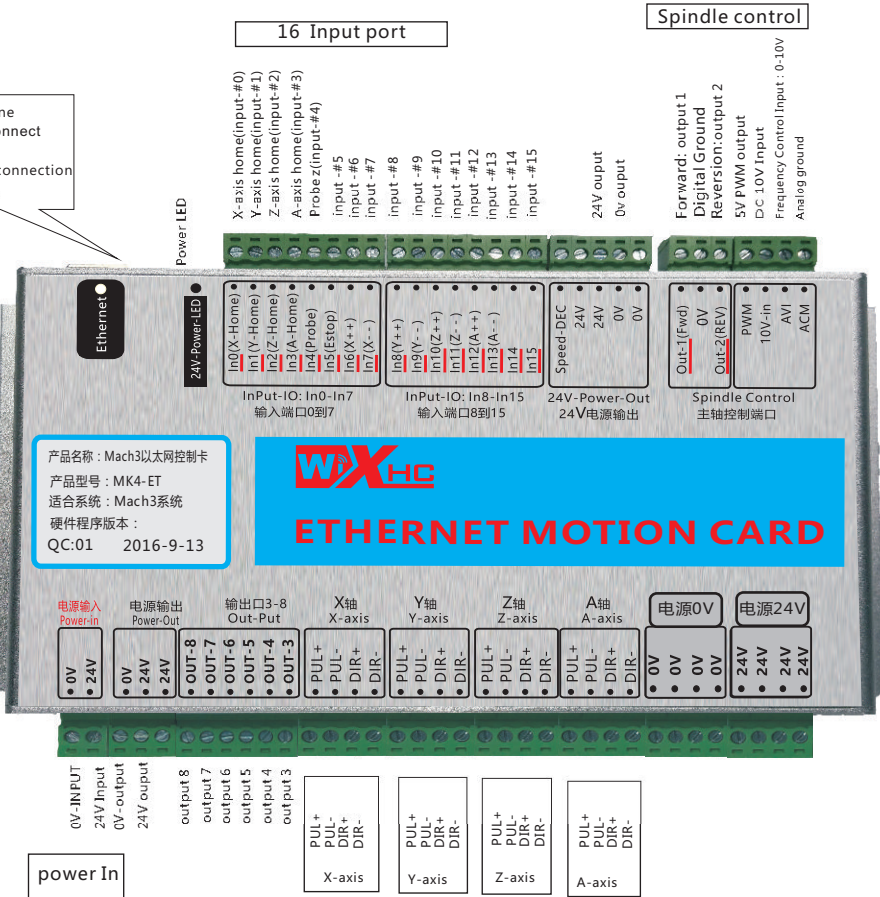

## Wiring diagram shows

NOTE: If the inverter is turned on, the control card is not working properly because of interference caused by the inverter; Replace inverter.

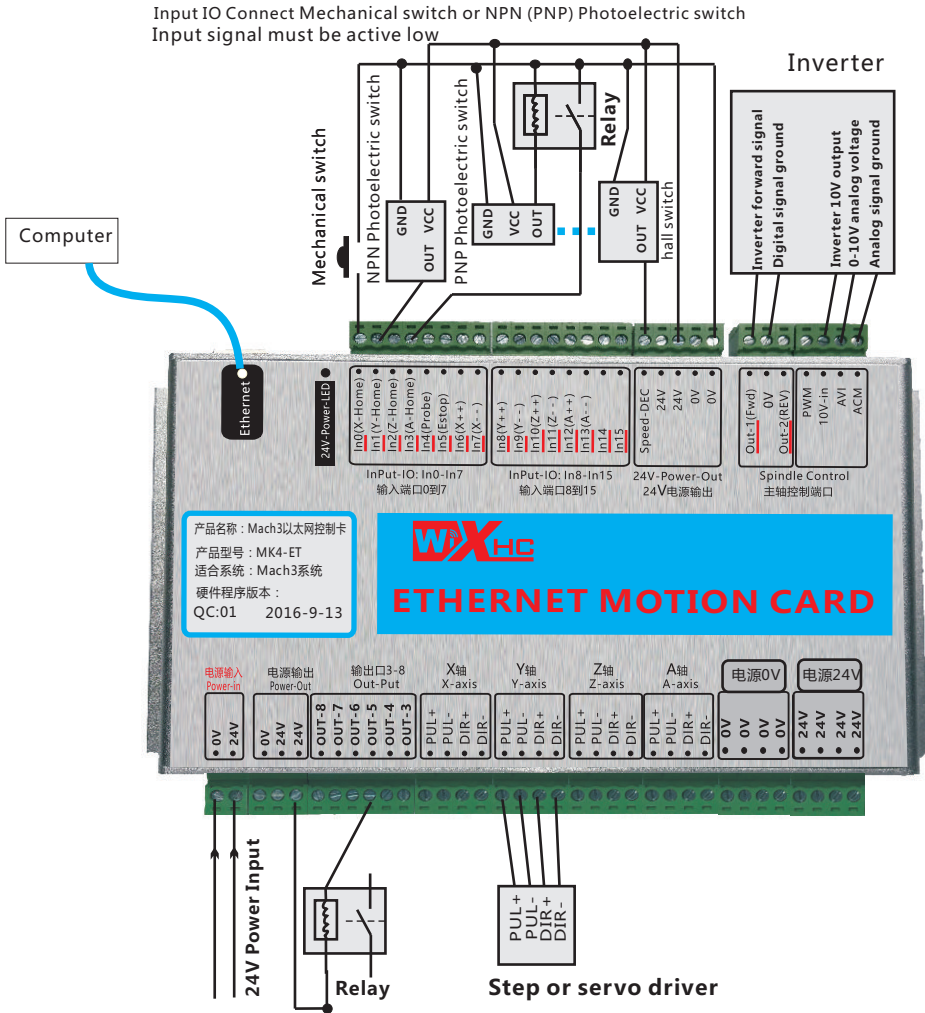

## Electrical Characteristics

	Parameter Description	
axis output control:	Drive Current	Isolated open collector output; 5V, 20mA
	Drive	Pulse + direction output
	Output frequency	2000KHZ
	axes	MK3-ET:3-axis;MK4-ET:4-axis;MK6-ET:6-axis
	Isolation Voltage	3.5KV
Spindle inverter output: 3 types of output modes	Analog voltage output	0—10V
	PWM output	5V,1KHZ, Duty;0-100%
	Pulse+direction output	5V,15HZ to 4KHZ
8 IO output	Drive Current	Isolation:50mA, 25V
	Isolation Voltage	3.5KV
16 IO input	Input Current	Isolated inputs, 5 mA, maximum voltage 25V
	Isolation Voltage	3.5KV

## Software installation

- First, Install Mach3 software to your PC.
- Second, copy our driver into mach3. Check [readme](#) file in the CD
- Check our wiring for reference, connect our card to your machine correctly
- Connect your PC to our card by using network cable
- After these steps, you can open your Mach3 software for operating



Please take a look at mach3 software parameters setting, Step per and so on in the printed manual of our packing box for reference.

1. Offer power supply to our card

DC24V,0.5A

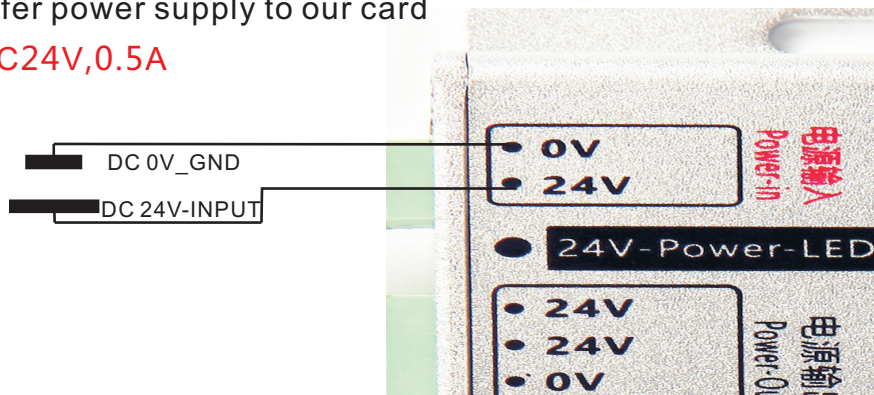

2. Drive connection.

Our card support Servo or stepper drive, Differential output signal



### NO.3 : Inverter wiring for reference

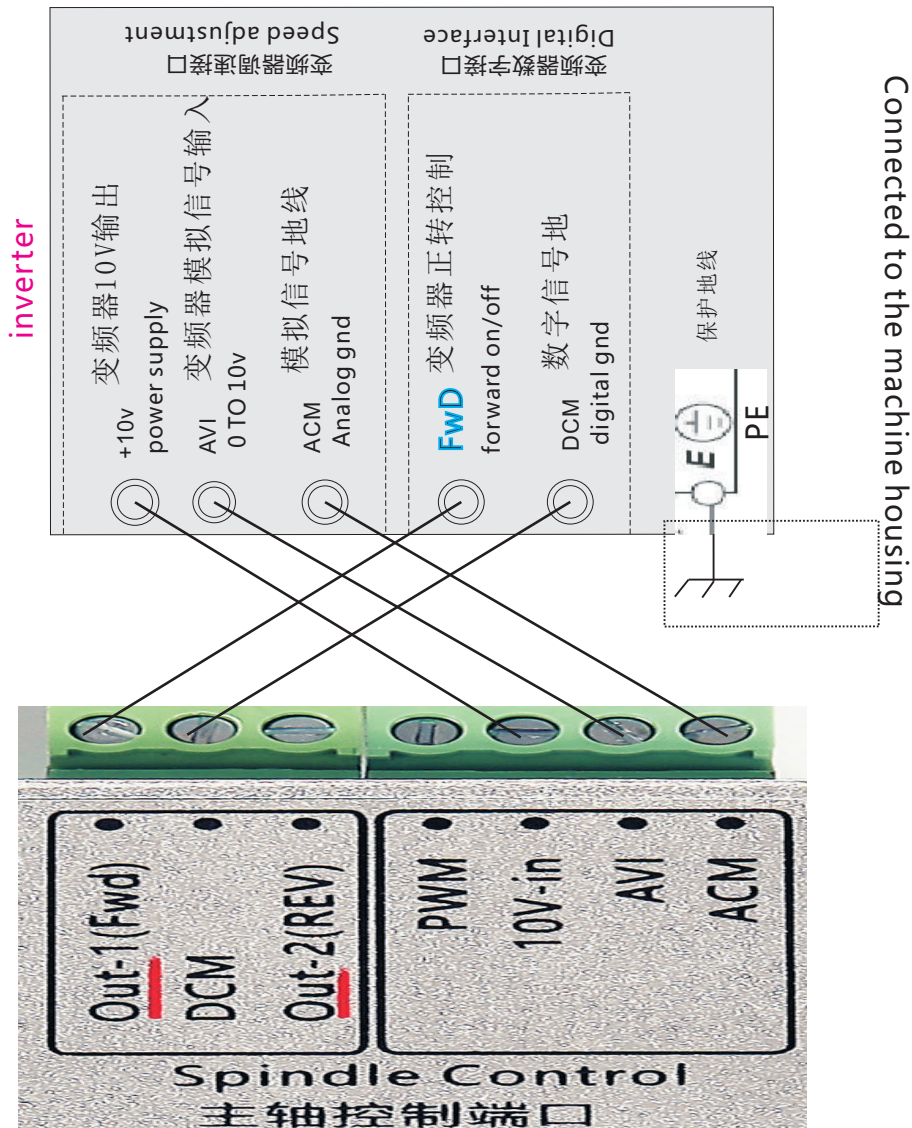

## MKX Wiring

Spindle connected stepper or servo drives

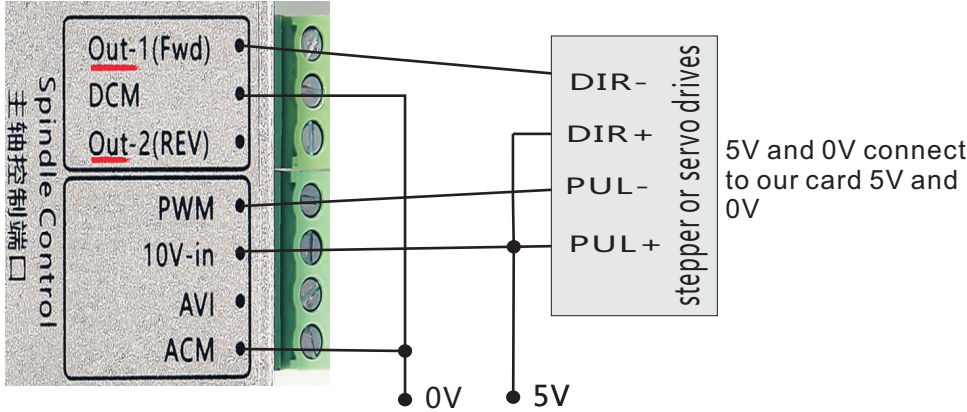

NO.4 : Output Relay Interface : OUT3 to OUT8 Relay Interface

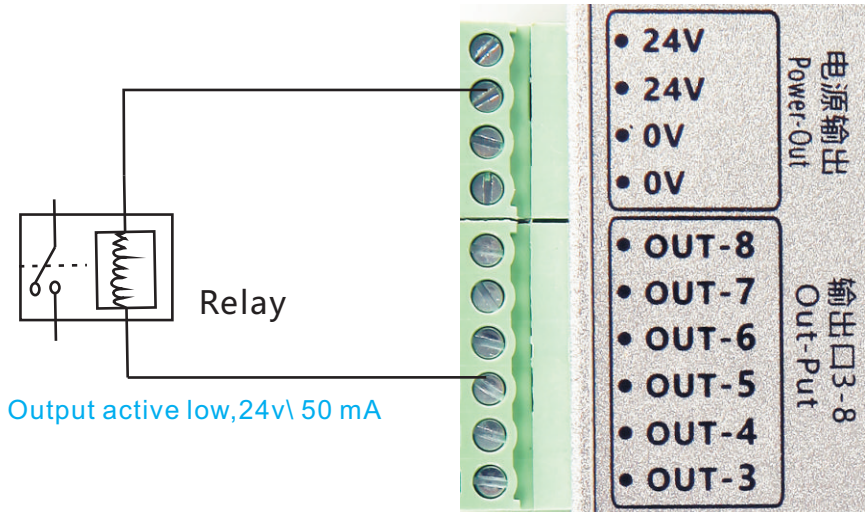

NO.5 : Input Io : 16 Input port;In0 to In15.Active Low

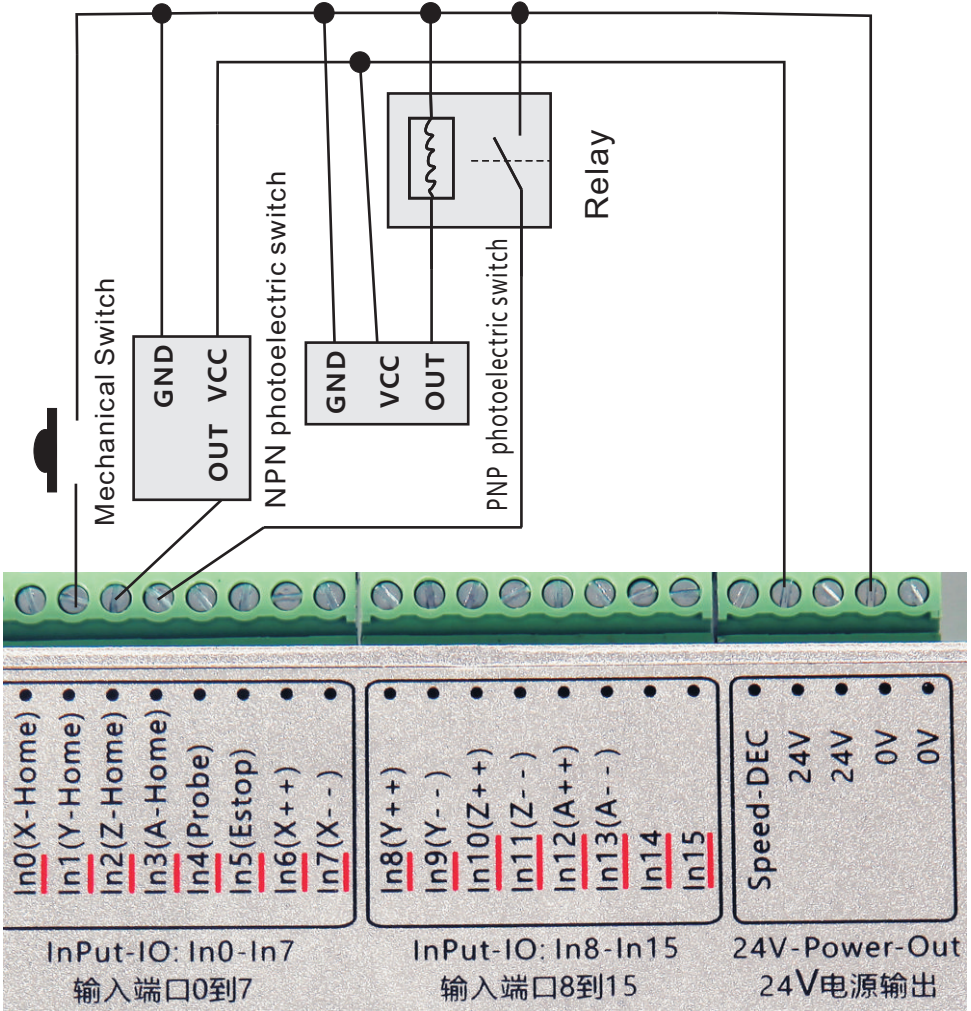

New Function

## G-code line quantity save function

When our control card suddenly power off, the control card chip automatically save the current G code line number. Control card plug-in display save the number of lines.

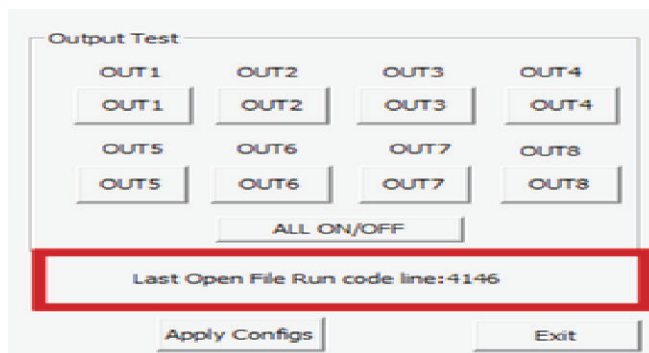

Wait until the control card is connected to the power supply next, load the G code program, click the power to continue to the break continue button, Mach3 software automatically from the last save the number of lines to start running.

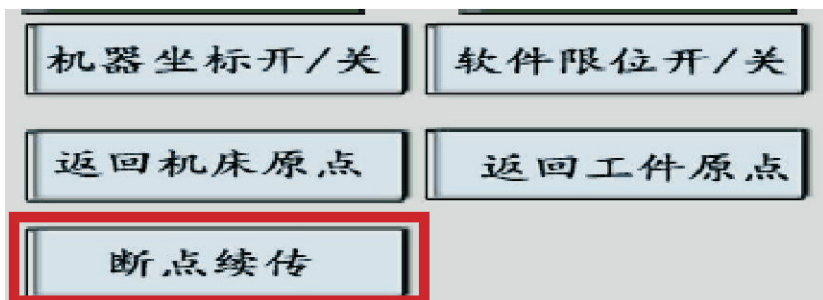

## Spindle speed feedback

Current Spindle rotary speed send to our card port "Speed-DEC", then display RPM speed on Mach3. Maximum support feedback input Pulse frequency 20KHZ.

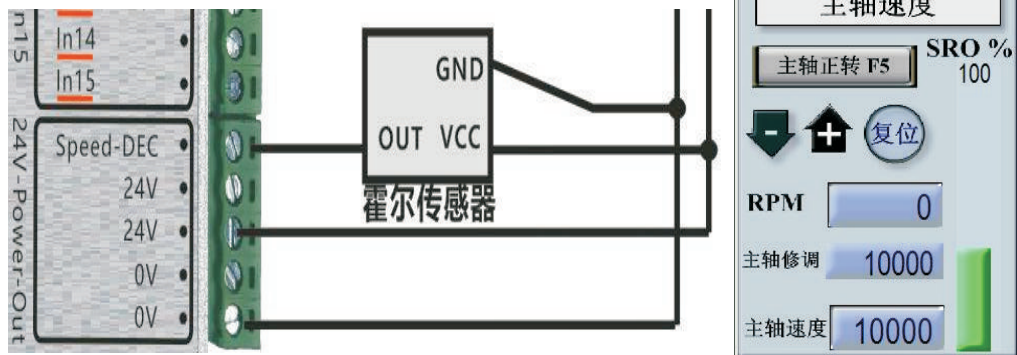

## First step: the computer IP address setting.

<Ethernet card directly connected to the computer> Please open "network sharing center", select the "local connection - property", open "Internet protocol version 4 (TCP/IPV4)", and manual input IP address 192.168.1.xx (XX from 0-179, can not be repeated)

### Ethernet card connected to the router

If your Ethernet card is connected to your computer via a router, Please make sure your router IP address format is 192.168.1.xx , If not, modify your router IP address into 192.168.1.xx format. Otherwise unable to communicate. Modify the IP address of the router, and then manually set the IP address of the computer in accordance with the above method.

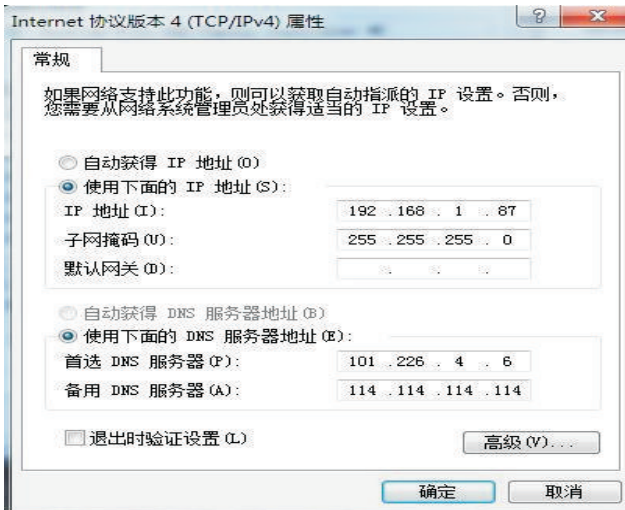

### The second step: Ethernet card Mach3 software IP address Setting

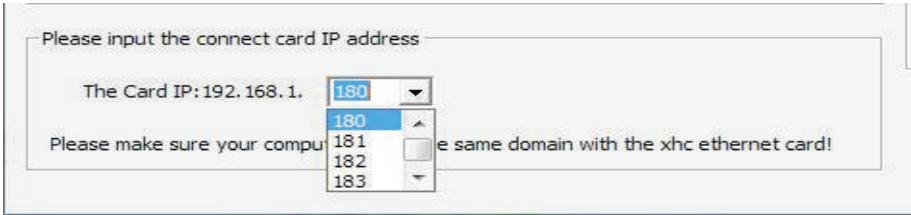

After PC IP address is set up, open the Mach3 software "plug-in control" in the figure below the location of the choice of a IP address, range: 180-195. (If you have only one set of control card, skip this setting. Factory defaults IP:180)





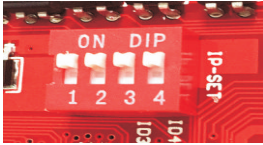
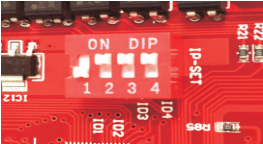

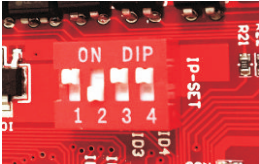
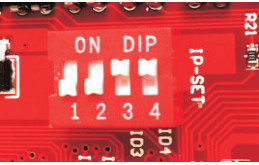
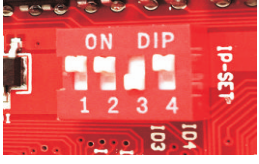
### The third step: IP internal Ethernet switch setting

if you only connected with 1 set of our Ethernet control card, skip the step. IP factory default is 180 open Ethernet control card control card circuit board in the shell, the upper inner has a red dial switch, a total of 4 of them. You can set the IP, range: 0-15, corresponding to the IP address of the Mach3 software plug-in control: 180-195.default all dial switch goes to the ON position, IP address is 0, corresponding to Ethernet IP of Mach3 software: 180 Refer to the following table settings:

拨码开关设置 Dial switch setting	对应Mach3软件IP地址 Mach3 software IP
	<p style="text-align: center; font-size: 24px;"><b>IP:180</b></p>
	<p style="text-align: center; font-size: 24px;"><b>IP:181</b></p>

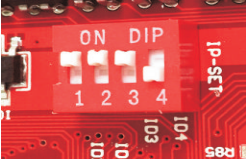
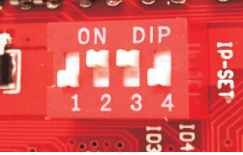
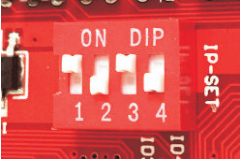
拨码开关设置 Dial switch setting	对应Mach3软件IP地址 Mach3 software IP
	IP:182
	IP:183
	IP:184
	IP:185
	IP:186
	IP:187



拨码开关设置 Dial switch setting	对应Mach3软件IP地址 Mach3 software IP
	IP:188
	IP:189
	IP:190
	IP:191
	IP:192
	IP:193

New Function

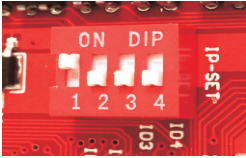
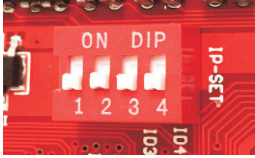
拨码开关设置 Dial switch setting	对应Mach3软件IP地址 Mach3 software IP
	IP:194
	IP:195



成都芯合成科技有限公司  
Chengdu XinHeCheng Technology Co.,Ltd  
<http://www.cdxhctech.com>

如有印刷或翻译错误，望用户谅解。产品设计和规格如有变化，恕不另行通知。  
此使用手册的出版日期为2016年2月。关于此日期后上市的产品驱动程序的变化，  
请登录公司网站查看并更新，或与我们售后联系。